

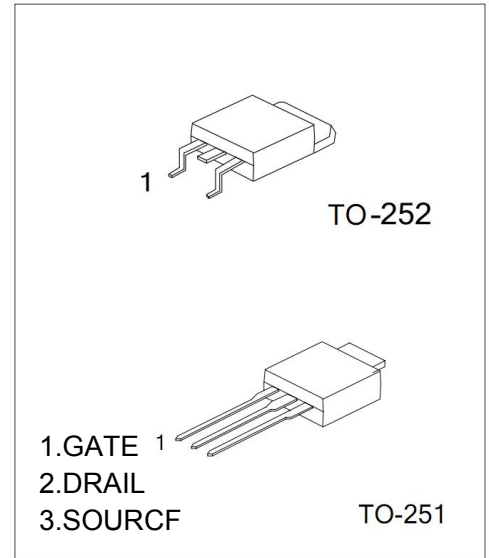

MK3015P P-Channel 30-V(D-S) Power MOSFET

V(BR)DSS	RDS(on)MAX	ID
-30 V	11mΩ@ -10 V	-50A
	14mΩ@ -4.5 V	

Equivalent Circuit:



General Description:

The MK3015P is the highest performance trench P-ch MOSFETs with extreme high cell density , which provide excellent RDSon and gate charge for most of the synchronous buck converter applications .

The MK3015P meet the RoHS and Green Product requirement , 100% EAS guaranteed with full function reliability approved.

Applications :

- High Frequency Point-of-Load Synchronous Buck Converter for MB/NB/UMPC/VGA
- Networking DC-DC Power System
- Load Switch

FEATURE:

- Advanced high cell density Trench technology
- Super Low Gate Charge
- Excellent CdV/dt effect decline
- 100% EAS Guaranteed
- Green Device Available

TO-252
Pin
Configuration :

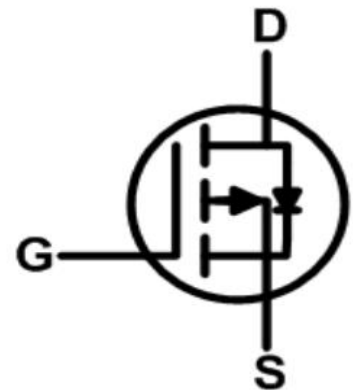

Absolute Maximum ratings (Ta=25°C unless otherwise noted)

Parameter	Symbol	Value	Unit
Drain-Source Voltage	VDS	-30	V
Gate-Source Voltage	VGS	±20	
Continuous Drain Current	ID	-50	A
Pulsed Drain Current ²	IDM	-120	
Single Pulse Avalanche Energy ³	EAS	408	mJ
Avalanche Current	IAS	-55.4	A
Total Power Dissipation ⁴	PD	52.1	W
Thermal Resistance from Junction to Ambient (t≤10s)	RθJA	25	°C/W
Operating Junction	TJ	150	°C
Storage Temperature	TSTG	-55~+150	



Static Electrical Characteristics (Ta = 25 °C Unless Otherwise Noted)

Parameter	Symbol	Test Condition	Min	Typ	Max	Unit
Static						
Drain-source breakdown voltage	V(BR)DSS	VGS = 0V, ID = -250μA	-30			V
Gate-source threshold voltage	VGS(th)	VDS = VGS, ID = -250μA	-1		-3	V
Gate-source leakage	IGSS	VDS = 0V, VGS = ±20V			±100	nA
Zero gate voltage drain current	IDSS	VDS = -24V, VGS = 0V			1	μA
Drain-source on-state resistancea	RDS(on)	VGS = -10V, ID = -20A		9	11	mΩ
		VGS = -4.5V, ID = -10A		12	14	mΩ
Forward transconductancea	gfs	VDS = -4.5V, ID = -30A		26.5		S
Diode forward voltage	VSD	IS = -1A, VGS = 0V		-0.8	-1.3	V
Dynamic						
Input capacitance	Ciss	VDS = -15V, VGS = 0V, f = 1MHz		3448		pF
Output capacitance	Coss			508		pF
Reverse transfer capacitanceb	Crss			421		pF
Total gate charge	Qg	VDS = -15V, VGS = -4.5V, ID = -15A		33		nC
Gate-source charge	Qgs			10.7		nC
Gate-drain charge	Qgd			12.8		nC
Gate Resistance	Rg	f = 1MHz		6		
Switchingb						
Turn-on delay time	td(on)	VDD = -15V RL = 3Ω, ID = -15A, VGEN = -10V, Rg = 3.4Ω		8		ns
Rise time	tr			17.8		ns
Turn-off delay time	td(off)			78.4		ns
Fall time	tf			43.6		ns
Drain-Source Diode Characteristics						
Continuous Source-Drain Diode Current	IS				-50	A
Pulsed Diode forward Current	ISM				-180	A
Reverse Recovery Time	trr	IF = -20A, dI/dt = 100A/μs		29		ns
Reverse Recovery Charge	Qrr	IF = -20A, dI/dt = 100A/μs		15		nC
Guaranteed Avalanche Characteristics						
Single Pulse Avalanche Energy5	EAS	VDD = -25V, L = 0.1mH, IAS = -30A	120			mJ

Note :

1. The data tested by surface mounted on a 1 inch² FR-4 board with 2OZ copper. .
2. The data tested by pulsed , pulse width ≤ 300us , duty cycle ≤ 2%
3. The EAS data shows Max. rating . The test condition is VDD=-25V,VGS=-10V,L=0.1mH,IAS=-55.4A
4. The power dissipation is limited by 150°C junction temperature
5. The Min. value is 100% EAS tested guarantee.



PACKAGE OUTLINE DIMENSIONS :

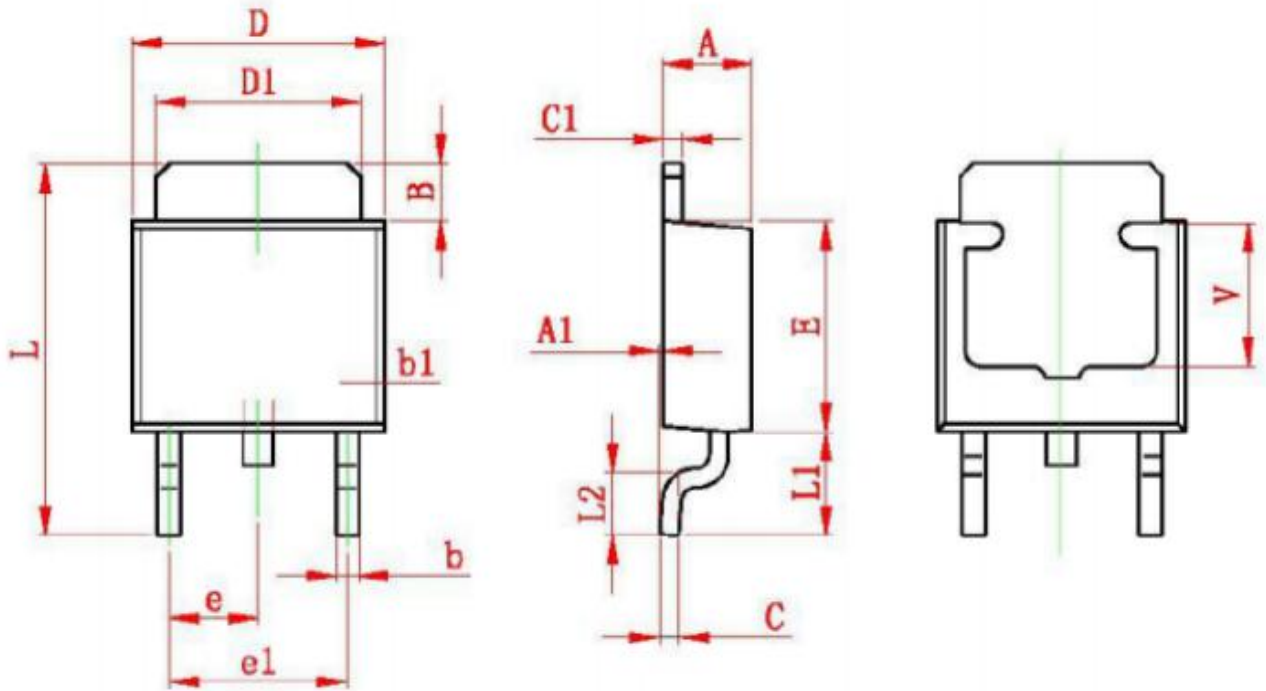

Symbol	Dimensions In Millimeters		Dimensions In Inches	
	Min	Max	Min	Max
A	2.200	2.400	0.087	0.094
A1	0.000	0.127	0.000	0.005
B	1.350	1.650	0.053	0.065
b	0.500	0.700	0.020	0.028
b1	0.700	0.900	0.028	0.035
c	0.430	0.580	0.017	0.023
c1	0.430	0.580	0.017	0.023
D	6.350	6.650	0.250	0.262
D1	5.200	5.400	0.205	0.213
E	5.400	5.700	0.213	0.224
e	2.300 TYP		0.091 TYP	
e1	4.500	4.700	0.177	0.185
L	9.500	9.900	0.374	0.390
L1	2.550	2.900	0.100	0.114
L2	1.400	1.780	0.055	0.070
V	3.80 REF		0.150 REF	



PACKAGE OUTLINE DIMENSIONS :

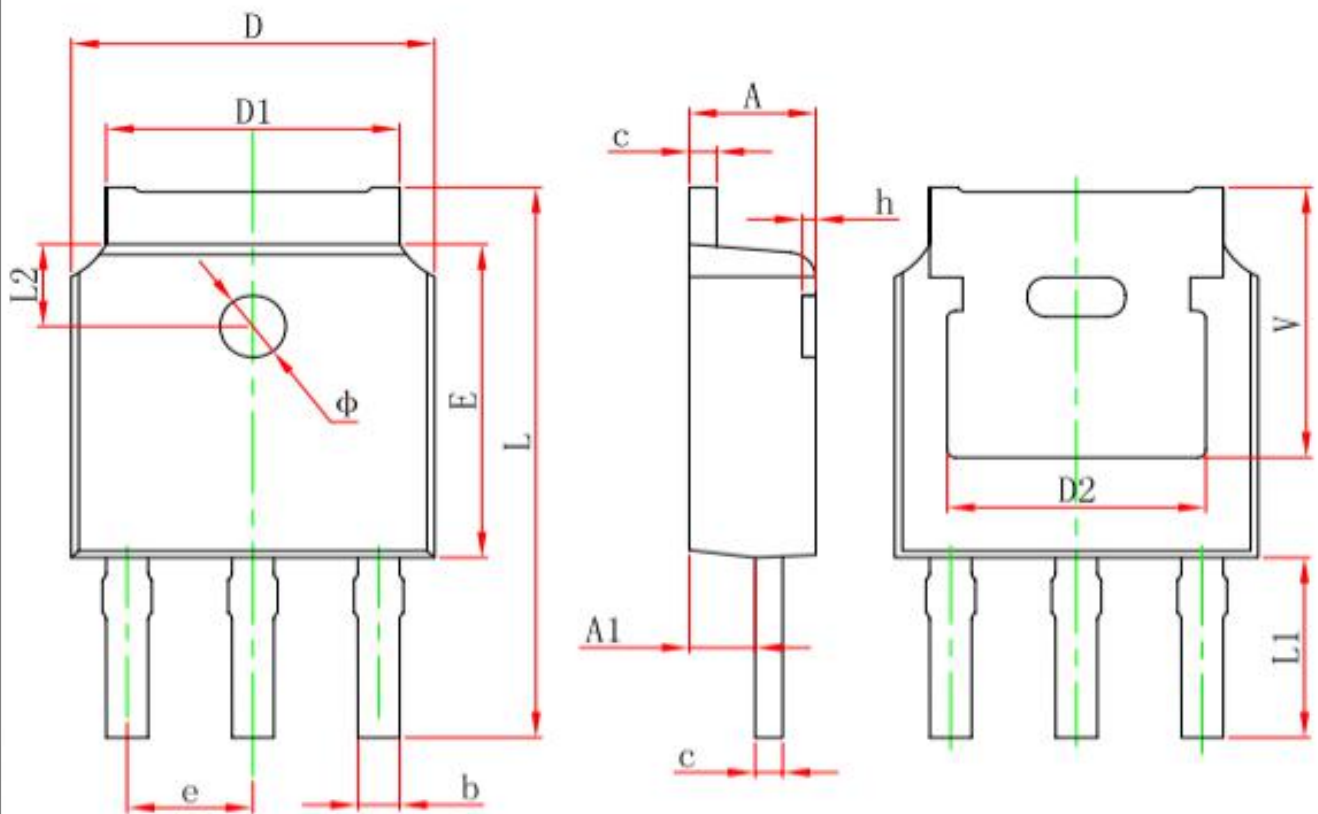

Symbol	Dimensions In Millimeters		Dimensions In Inches	
	Min.	Max.	Min.	Max.
A	2.200	2.400	0.087	0.094
A1	0.860	1.160	0.034	0.046
b	0.660	0.860	0.026	0.034
c	0.460	0.580	0.018	0.023
D	6.500	6.700	0.256	0.264
D1	5.100	5.460	0.201	0.215
D2	4.830 REF.		0.190 REF.	
E	6.000	6.200	0.236	0.244
e	2.186	2.386	0.086	0.094
L	10.400	11.000	0.409	0.433
L1	3.300	3.700	0.130	0.146
L2	1.600 REF.		0.063 REF.	
Φ	1.100	1.300	0.043	0.051
h	0.000	0.300	0.000	0.012
V	5.350 REF.		0.211 REF.	



Typical Characteristics :

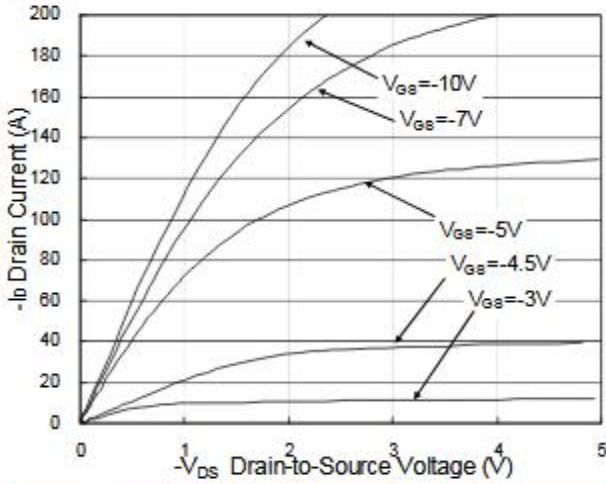

Fig.1 Typical Output Characteristics

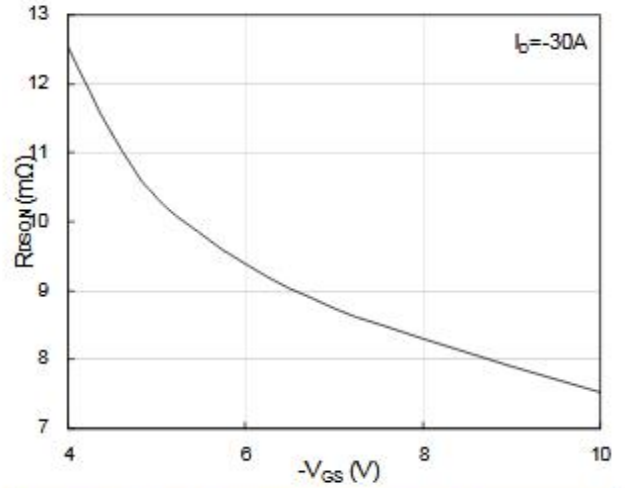

Fig.2 On-Resistance v.s Gate-Source

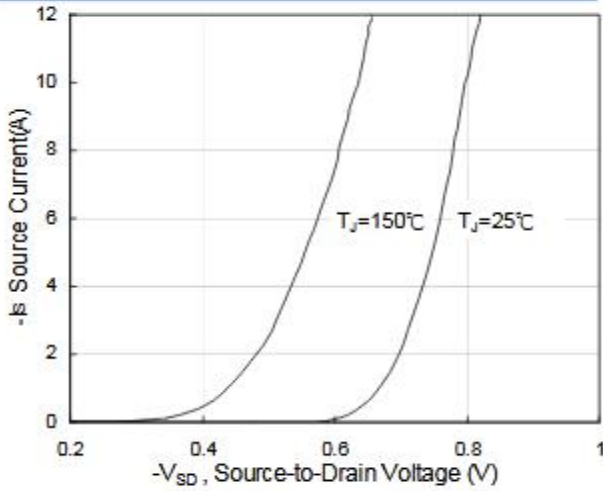

Fig.3 Forward Characteristics Of Reverse

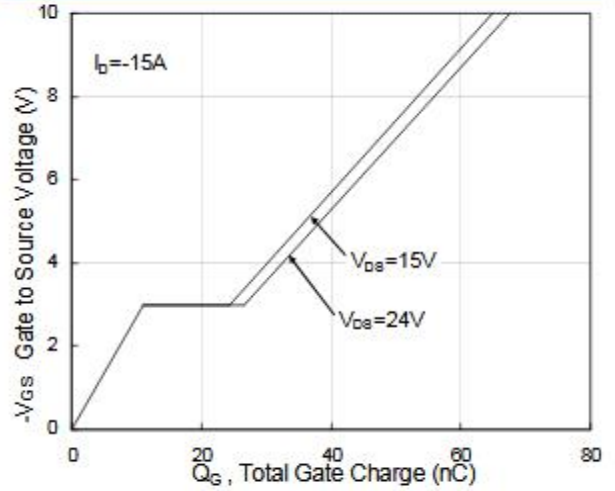

Fig.4 Gate-Charge Characteristics

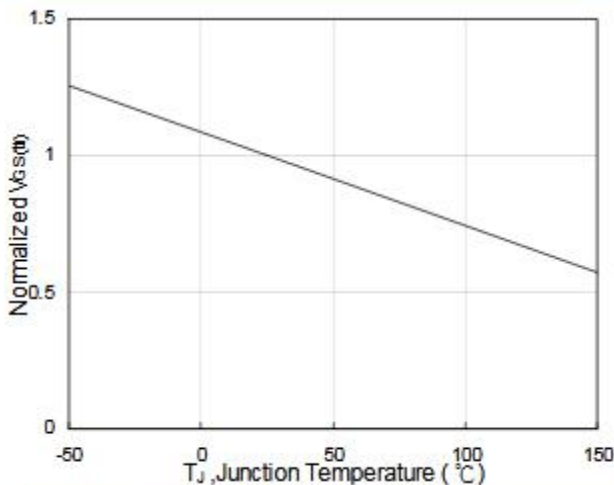

Fig.5 Normalized $V_{GS(th)}$ v.s T_J

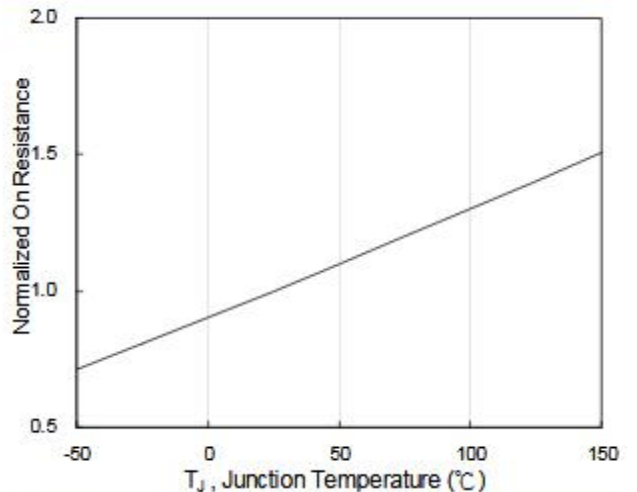

Fig.6 Normalized $R_{DS(on)}$ v.s T_J



Typical Characteristics :

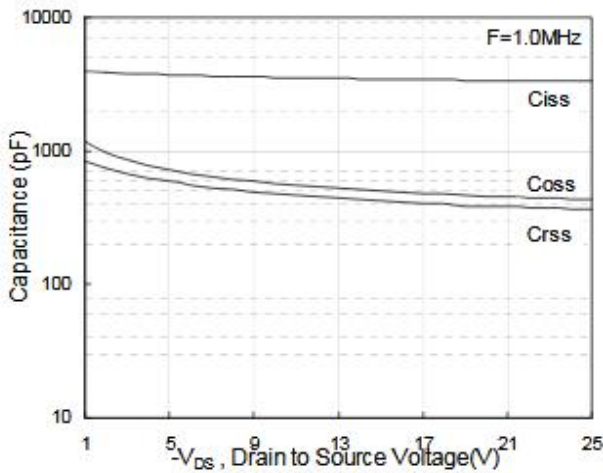

Fig.7 Capacitance

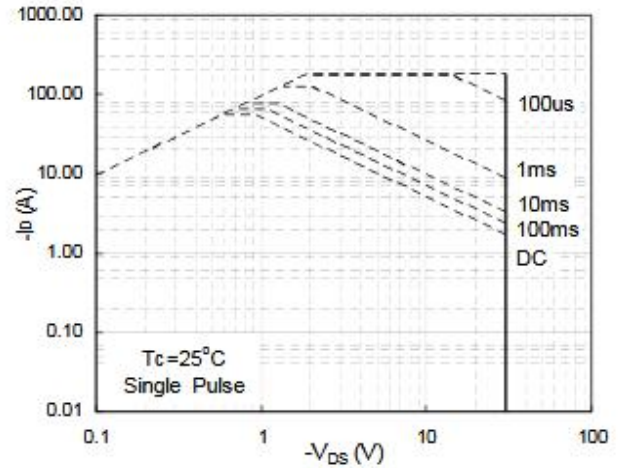

Fig.8 Safe Operating Area

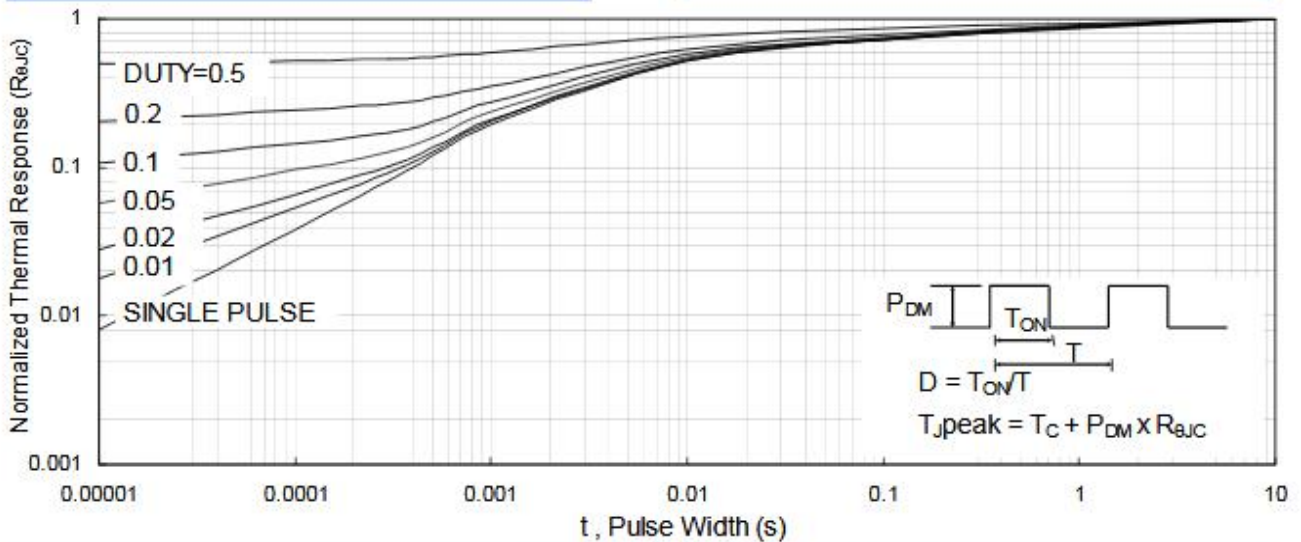

Fig.9 Normalized Maximum Transient Thermal Impedance

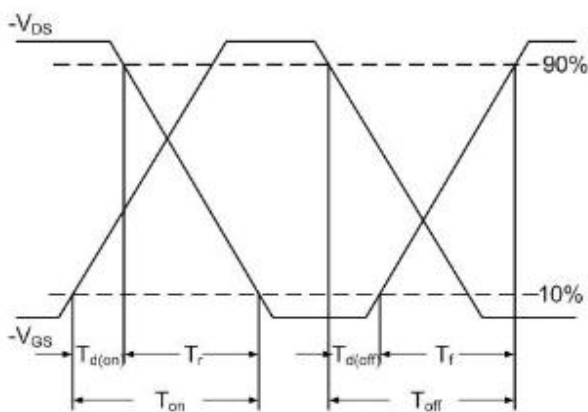

Fig.10 Switching Time Waveform

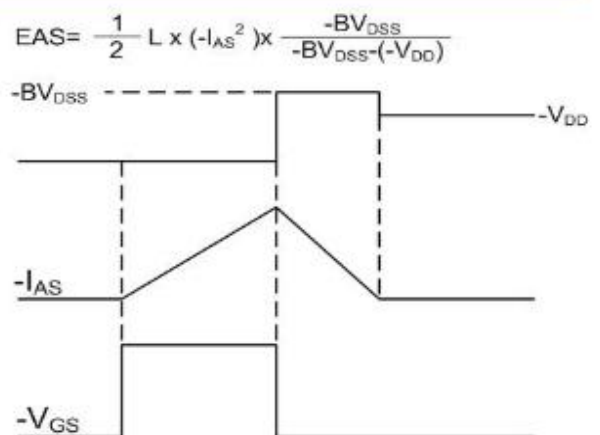

Fig.11 Unclamped Inductive Switching Waveform